

SISTEMA AMERICANO.

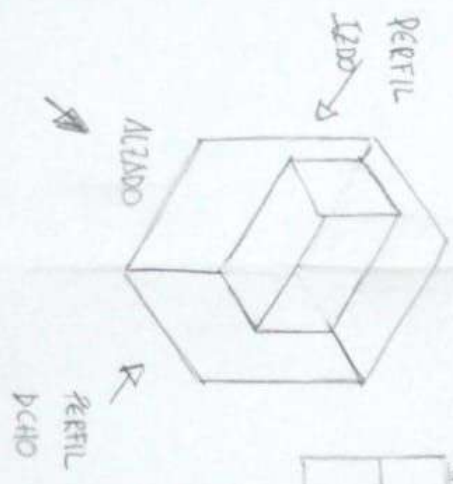

*



SISTEMA EUROPEO.

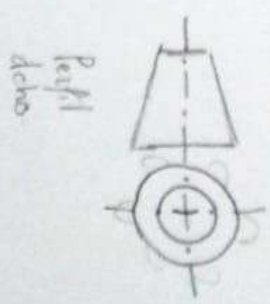
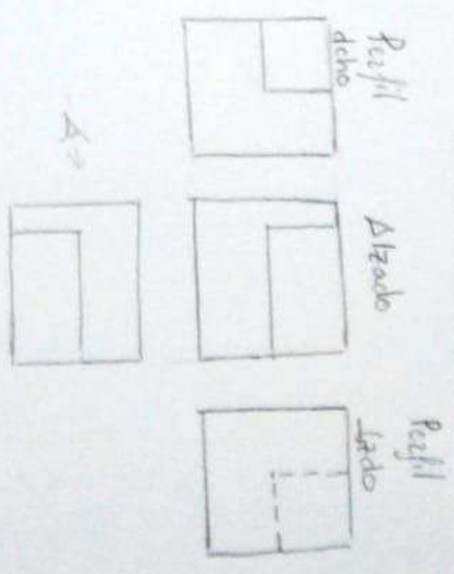

1

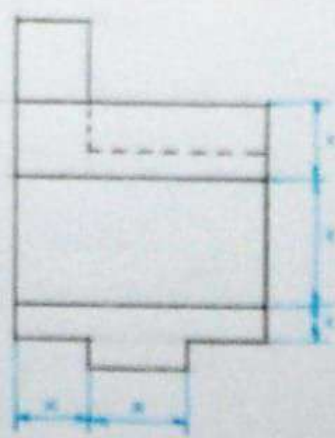
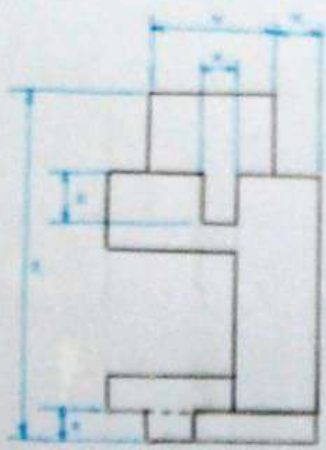
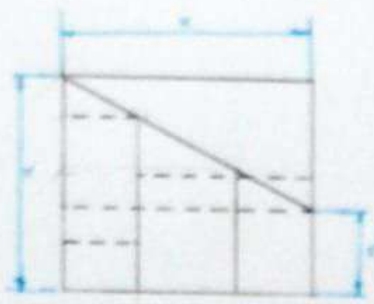
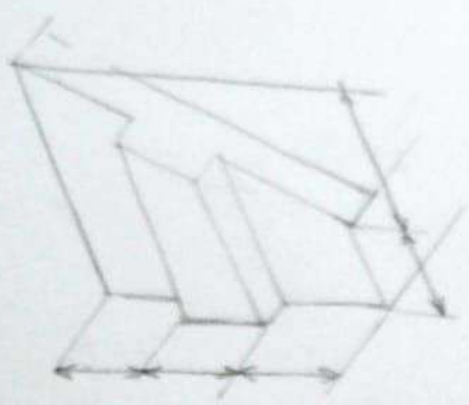
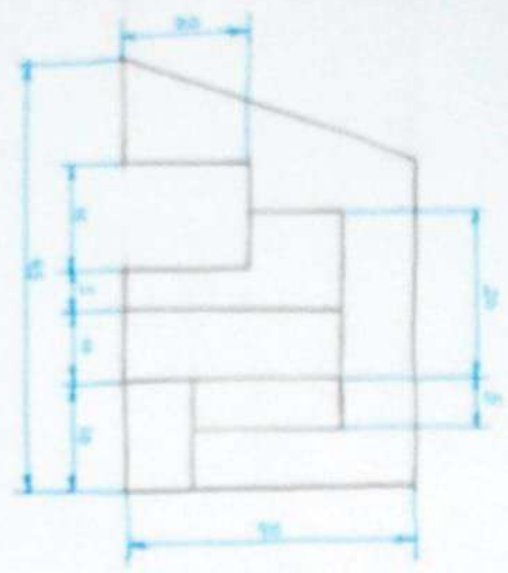
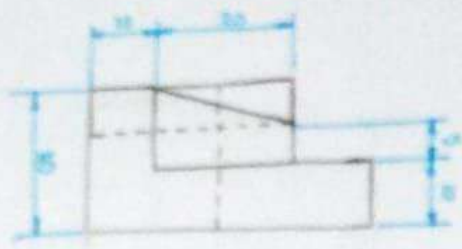

K / 11 / 15 / X

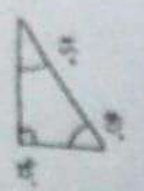
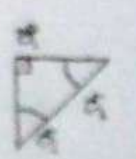

ACOTAR

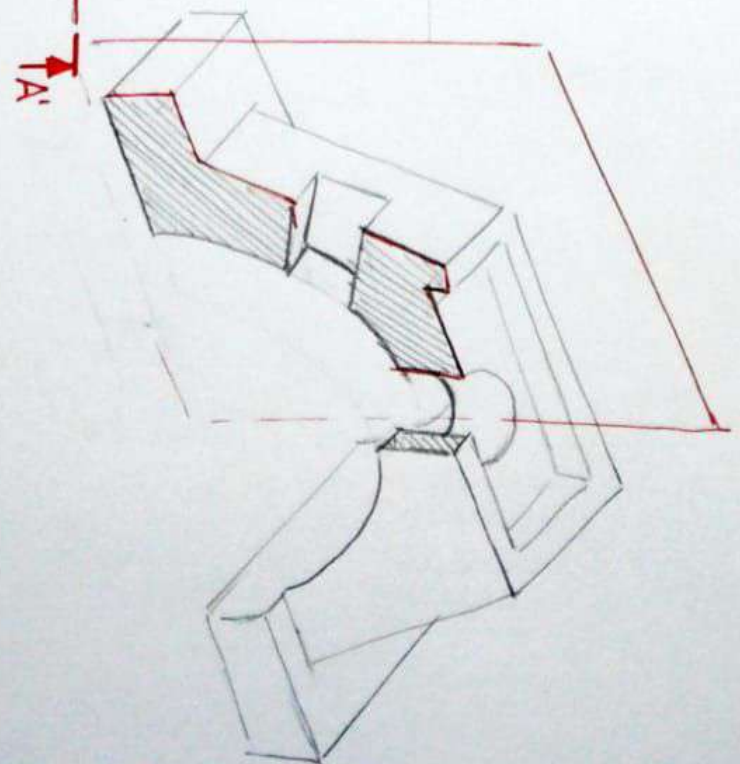
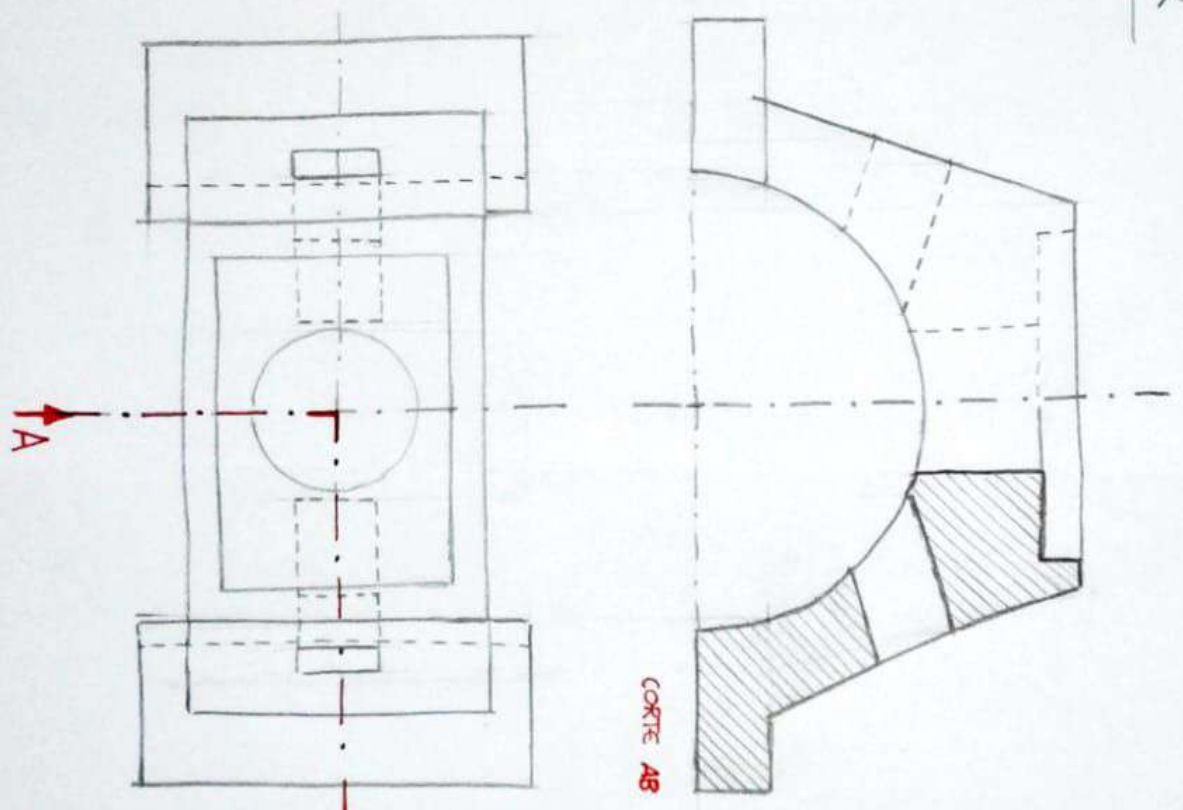

CORTES Y SECCIONES

ARMAS
DETALLES

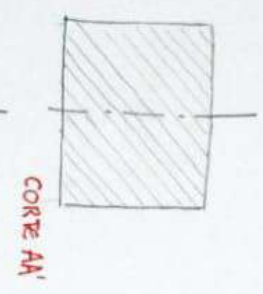
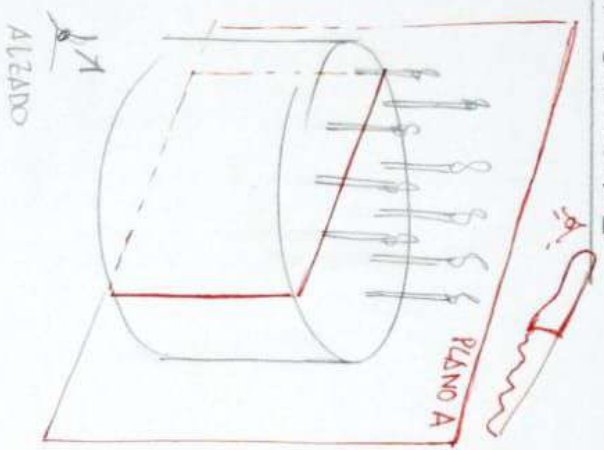

CORTE A-A'

CORTE COMPLETO.

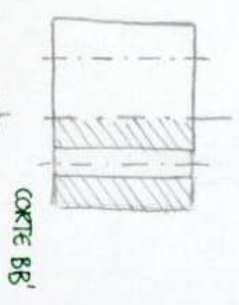
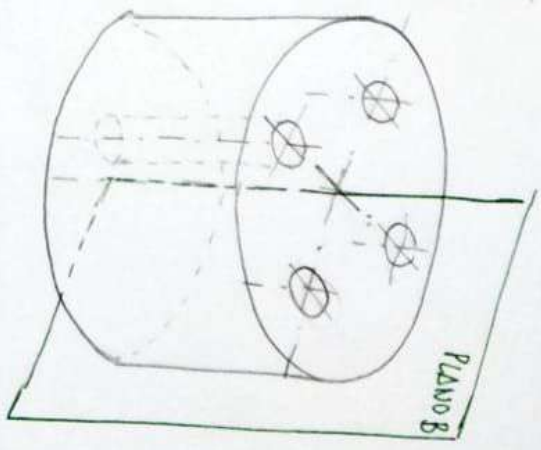

CORTE B-B'

MEDIO
CORTE

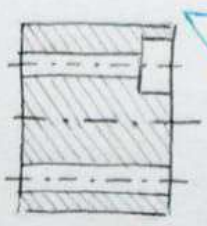
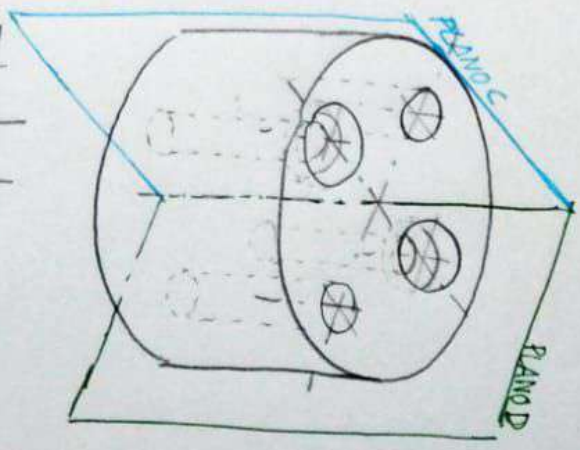

CORTE
AL CUARTO

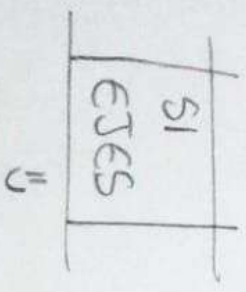

EN CORTES
NO SE DIBUSAN
DISCONTINUAS

EN LA PARTE DEL ALZADO

TAMPOCO SE DIBUSAN DISCONTINUAS.

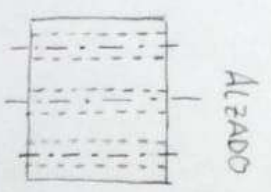

ALZADO

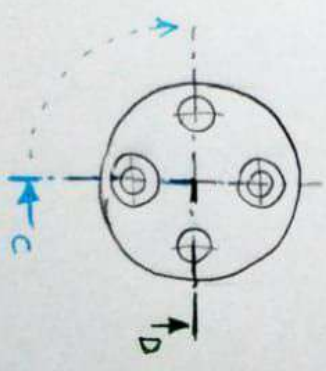

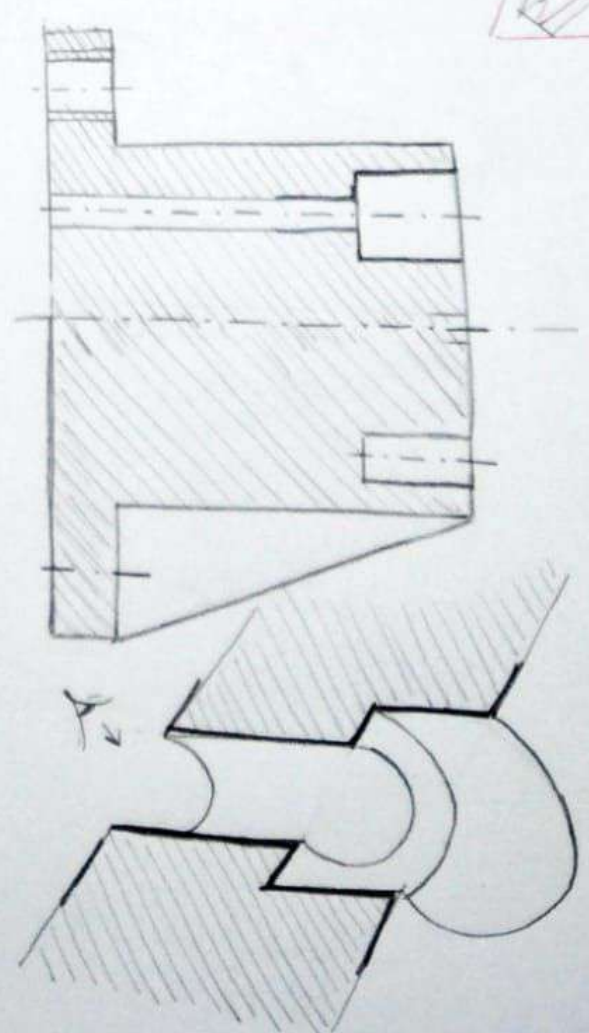
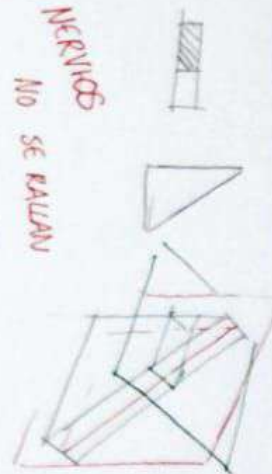
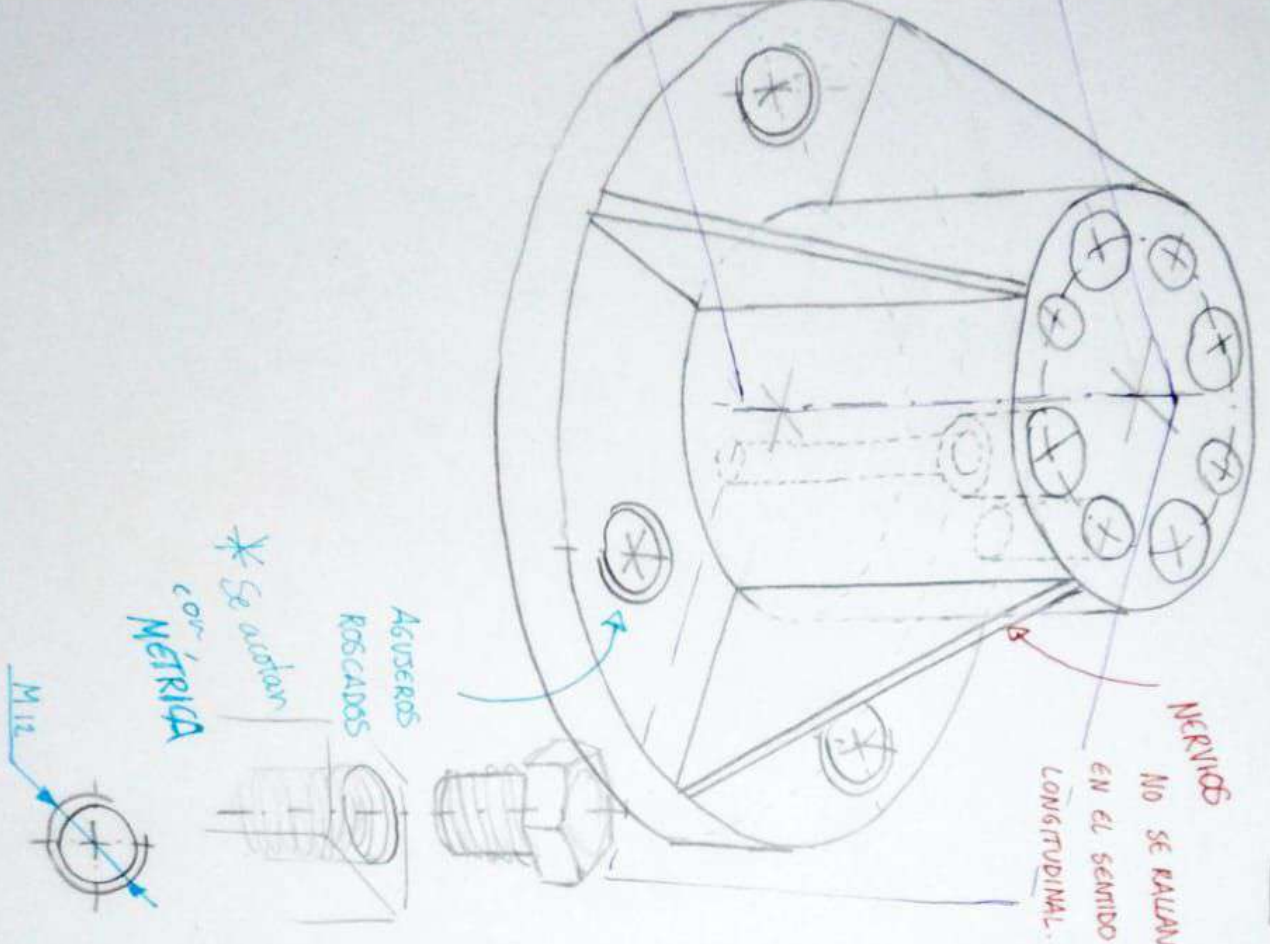

CORTE RADIAL
 (o circular)

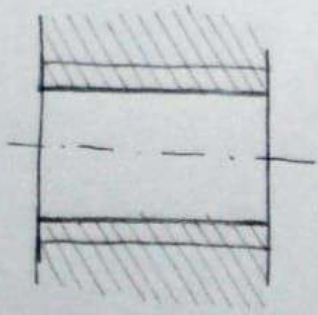
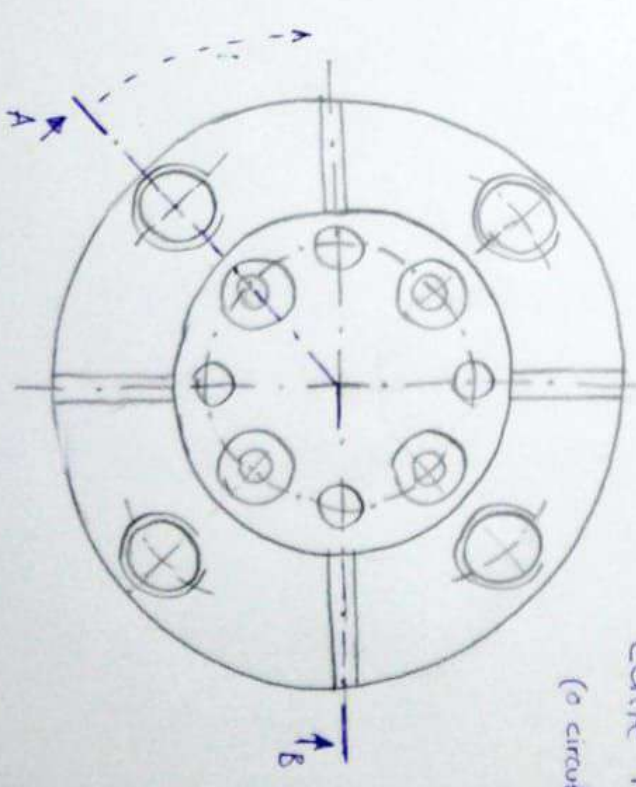

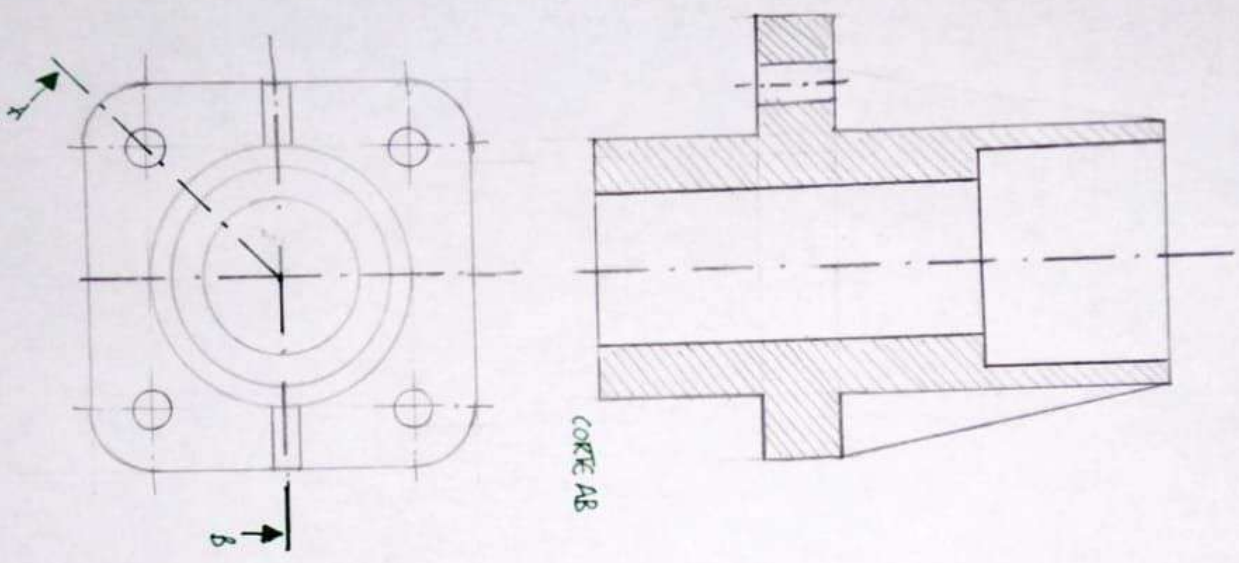

↙ ACOTAR.

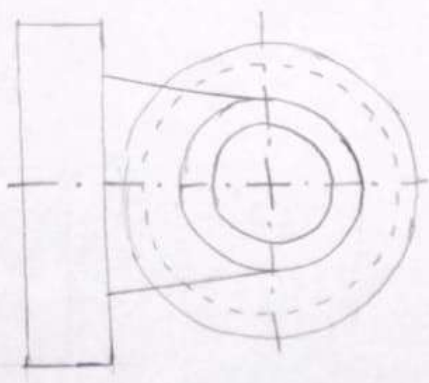

↙ ACOTAR

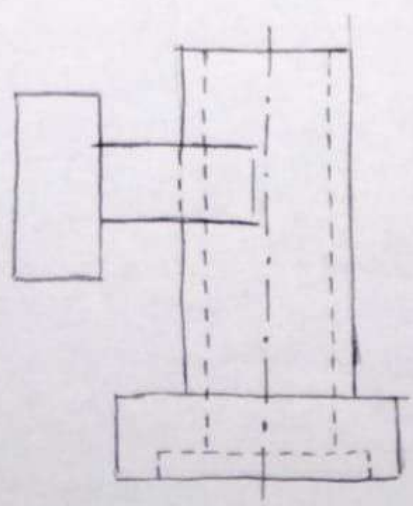

¿CORTES?