

PLANTA INFERIOR

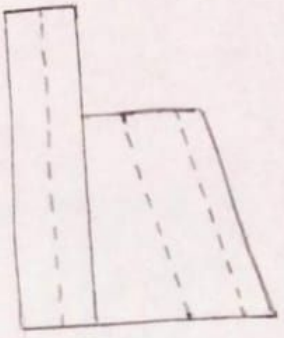

PERFIL DCHO



ALZADO

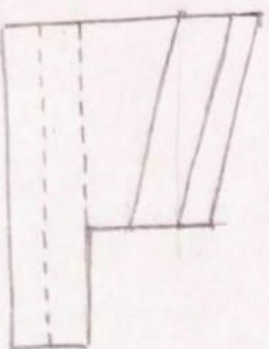

PERFIL IZDO

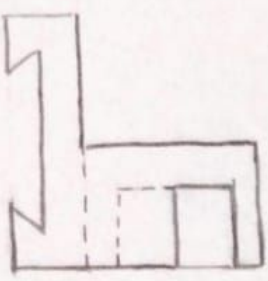

ALZADO POSTERIOR

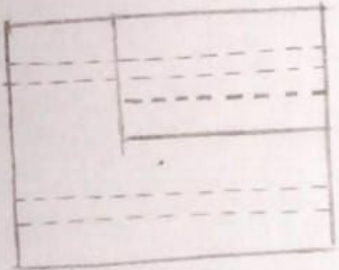

PLANTA

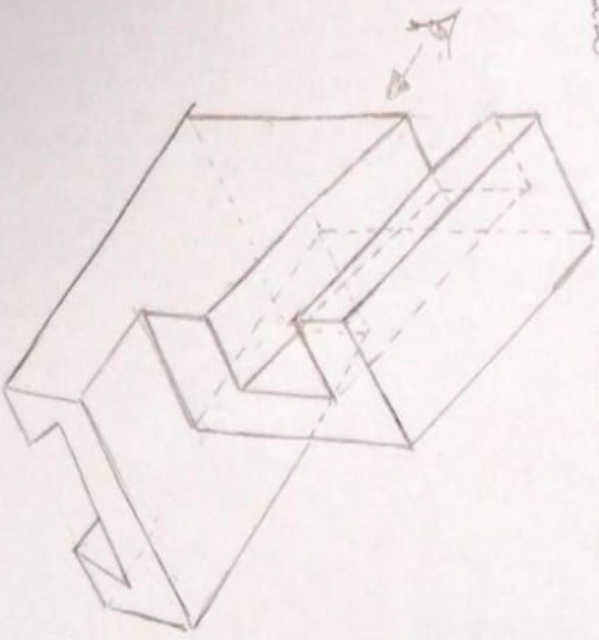

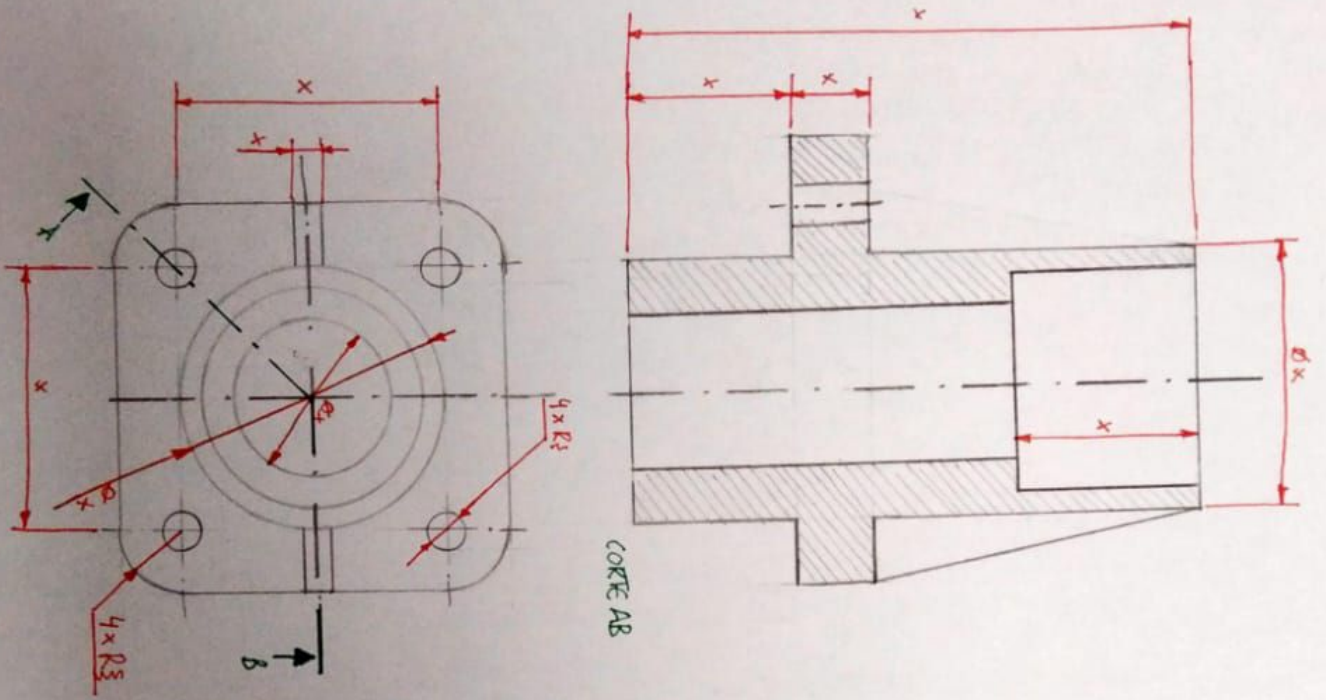

CORTE AB

ACOTAR.

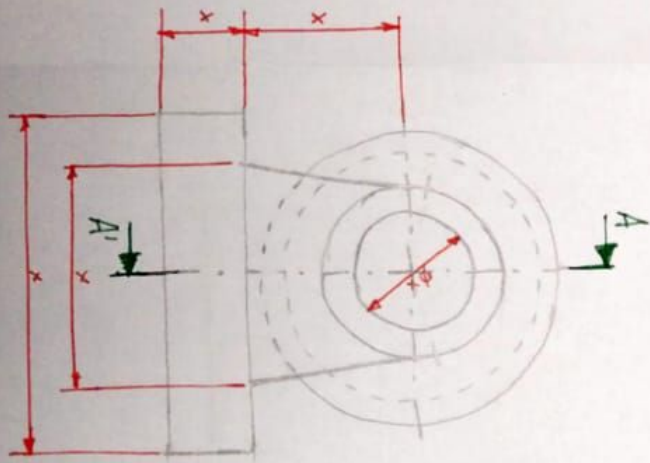

ACOTAR

¿CORTES?

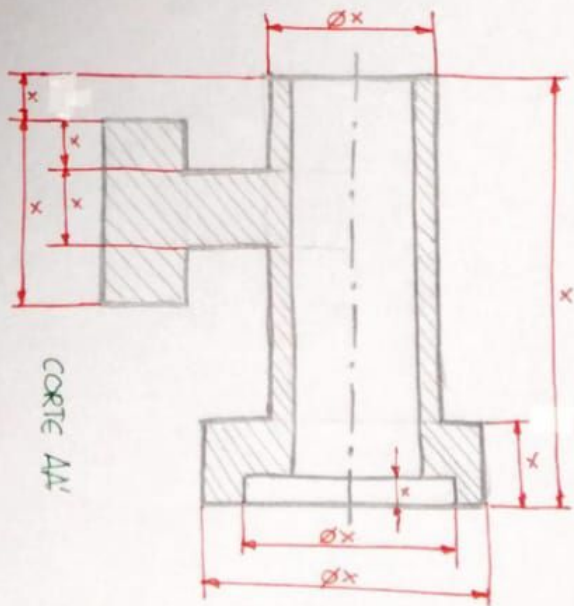

CORTE A-A'

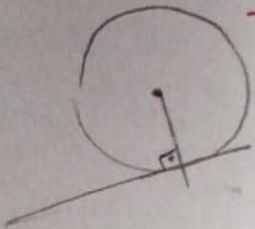

VISTAS 1:1

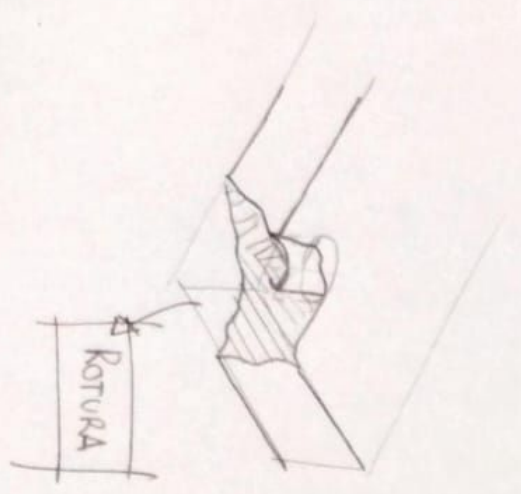
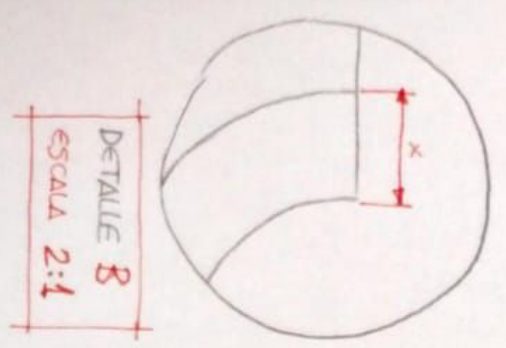
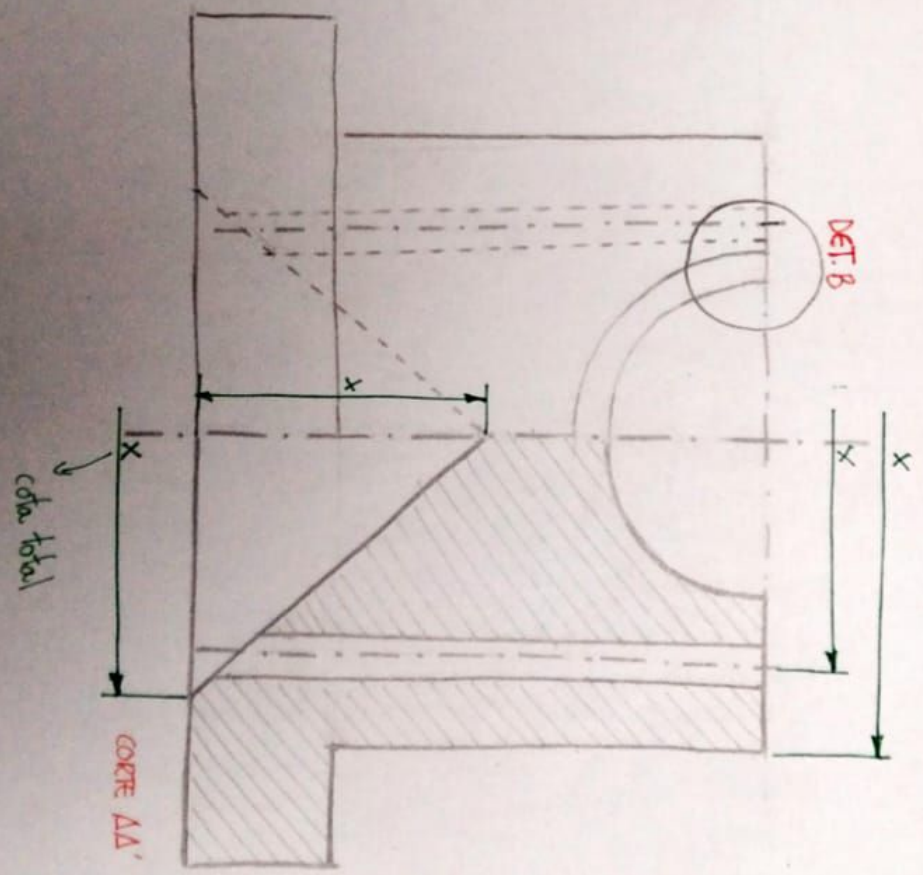
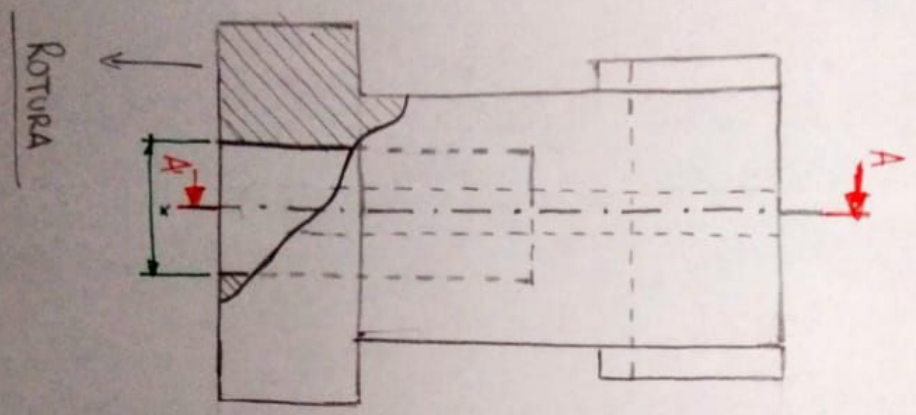

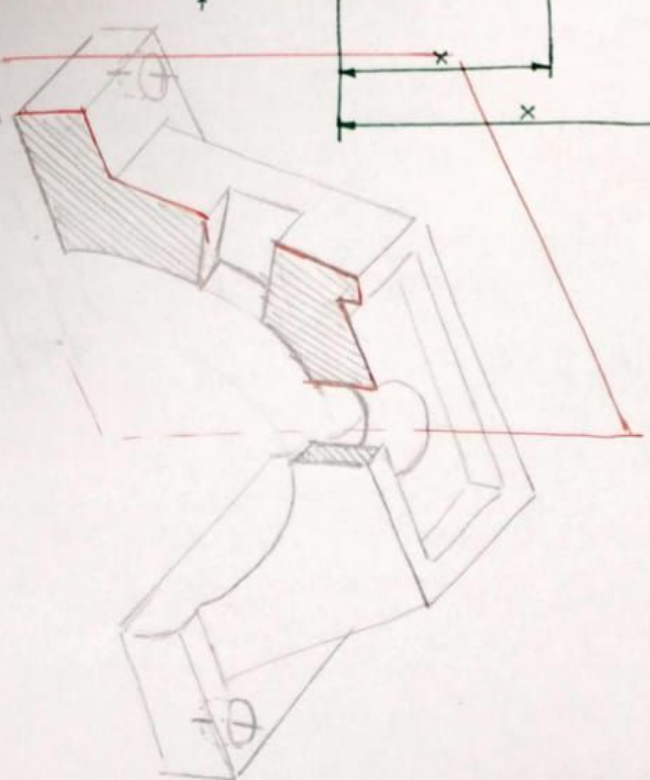
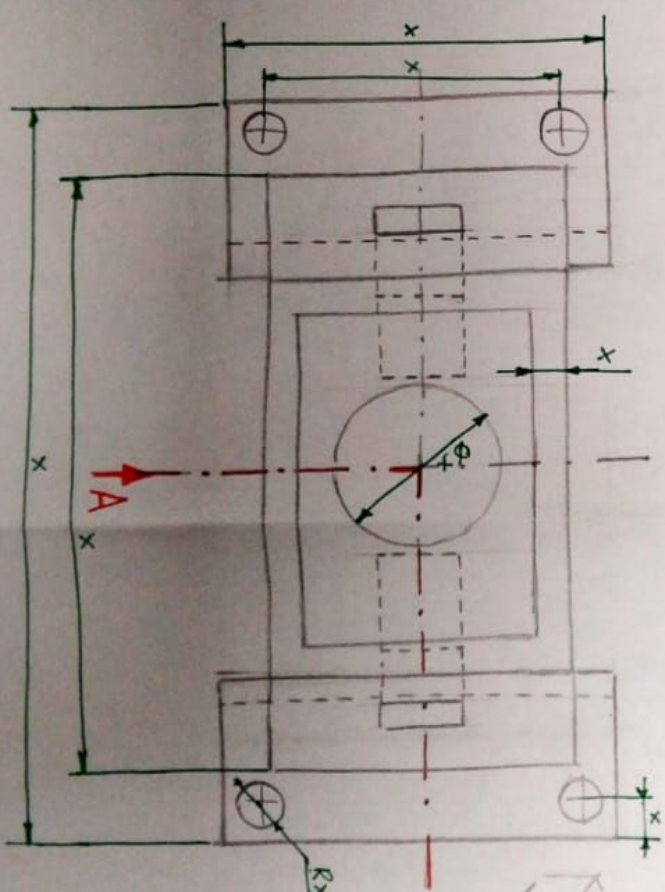
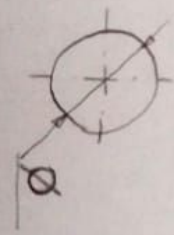
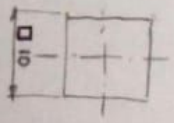

ROTURA

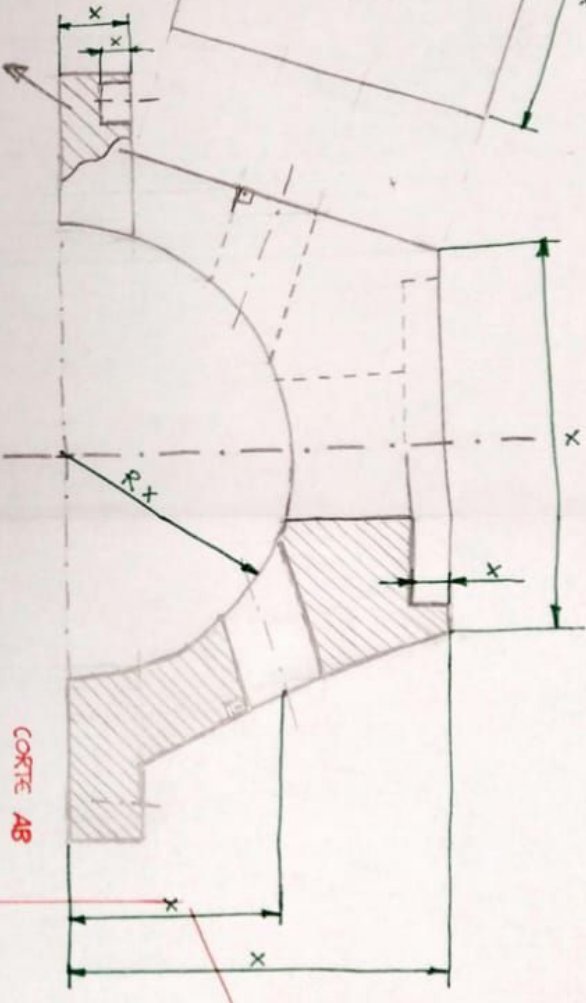

CORTE AB

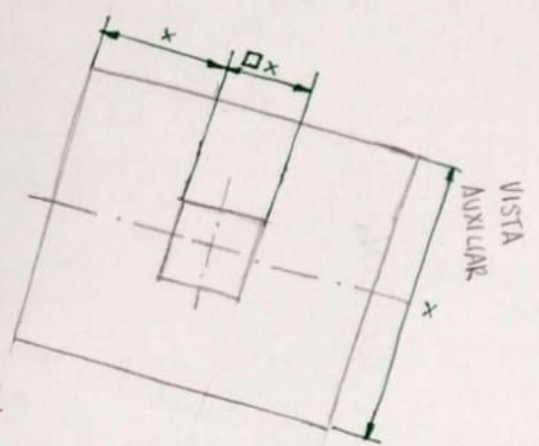

VISTA AUXILIAR